

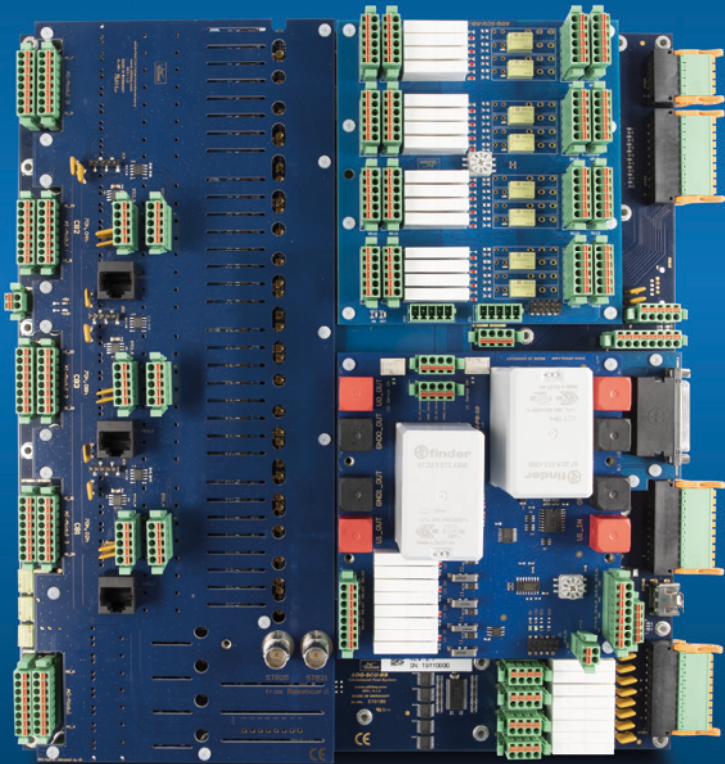

ADQ-SCU 2.3 Manual

Rev. 1.0 EN



**ALLDAQ signal conditioning unit baseboard,
optional powerboard and relay board**

Imprint

Manual ADQ-SCU 2.3
Rev. 1.0 EN
Date: 10.05.2021

Manufacturer and Support

ALLNET® and ALLDAQ® are registered trademarks of ALLNET® GmbH Computersysteme. For questions, problems and product information please contact the manufacturer directly:

ALLNET® GmbH Computersysteme

Division ALLDAQ
Maistrasse 2
D-82110 Germering

Support

E-Mail: support@alldaq.com
Phone: +49 (0)89 894 222 – 474
Fax: +49 (0)89 894 222 – 33
Internet: www.alldaq.com/support

© Copyright 2020 ALLNET GmbH Computersysteme. All rights reserved.

All information contained in this manual has been compiled with the greatest care and to the best of our knowledge. Nevertheless, errors cannot be completely ruled out. Specifications and contents of this manual are subject to change without notice.

We are always grateful for the notification of any errors.

Mentioned trademarks are registered trademarks of the respective companies.

Content

1. Introduction	7
1.1 Scope of delivery	7
1.2 Safety instructions	7
1.3 Installation and assembly site	8
1.4 Brief description	9
2. Overview of the system	10
2.1 Block diagram	10
2.2 Baseboard ADQ-SCU-BB	11
2.3 Powerboard ADQ-SCU-PB-50	12
2.4 Relay board ADQ-SCU-RB	13
2.5 ADQ-PROTECTION-COVER	14
2.6 Multifunction card ADQ-348	16
2.7 Example system configuration	17
3. Pin assignments	18
3.1 Position of the connectors	18
3.2 Prefixes of the connector designations	19
3.3 Overview of the connector types	19
3.3.1 Type Würth	19
3.3.2 Type Phoenix Contact	19
3.3.3 Type Pin plug	20
3.3.4 Type Würth	20
3.3.5 Mating connector for Würth connectors	20
3.3.6 Mating connector for Phoenix connectors	21
3.4 Baseboard (ADQ-SCU-BB)	22
3.4.1 Analog input section (STBA1..4/STBB1..4)	22
3.4.2 Analog output section (STBA5/STBB5)	23
3.4.3 Digital I/O section (STB6)	24
3.4.4 External trigger inputs for AI/AO part (STB8)	24
3.4.5 Counter, ignition signal & temperature alarm (STB9)	25
3.4.6 Pin assignment (STB10_A)	26
3.4.7 Special functions (STB10_B)	26
3.4.8 Switchable auxiliary voltages (STB11..14 > STB15)	27
3.4.9 Supply for baseboard (STB16)	29
3.4.10 HDMI connector for special functions (STB18)	29

3.4.11	Audio output (STB19)	31
3.4.12	Measuring signal tap (STB20..21)	31
3.4.13	Analoger AI-GND (AGND) STB1	32
3.4.14	68-pin VHDCI sockets from/to ADQ-34x	33
3.5	Powerboard (ADQ-SCU-PB)	34
3.5.1	Pin connector strip JB1 -> J1	34
3.5.2	High current supply switchable (ST1..8)	35
3.5.3	Sense connection (ST9)	35
3.5.4	Supply switchable (ST10, ST11)	36
3.5.5	Sense connection (ST12)	36
3.6	Relay board (ADQ-SCU-RB)	37
3.6.1	Pin connector strip JB2 -> JR2	37
3.6.2	Changeover relay (STR1..4)	38
3.7	Customer-specific plug-in boards (CB1..3)	39
4.	ADQ-SCU 2.2 BB App	41
5.	Monitoring stage with headphone amplifier	43
6.	Specifications	45
7.	Annex	55
7.1	Supplies	55
7.1.1	Cables	55
7.2	Manufacturer and support	55
7.3	Important notes	56
7.3.1	Packaging ordinance	56
7.3.2	Recycling advice and RoHS conformity	56
7.3.3	CE Identification	56
7.3.4	Warranty	56

1. Introduction

Please check the packaging and contents for damage and completeness before commissioning. Should any defects occur, please inform us immediately.

- Does anything on the packaging indicate that anything was damaged during transport?
- Are there any signs of use on the device?

Under no circumstances may you operate the device if it is damaged. If in doubt, contact our technical service department.

Please read - before installing and programming the device - this manual carefully!

1.1 Scope of delivery

- ALLDAQ Baseboard ADQ-SCU-BB for signal conditioning unit
- ALLDAQ ADQ-SCU-BTB adapter
- 2 x 68-pin VHDCI cable (male-male), double shielded, cables twisted in pairs, length: 1.8 m (ADQ-CR-VHDCI-68M/68M-1.8m), part no.: 146813 (2 x)

Optional:

- Plug-on board ALLDAQ Powerboard ADQ-SCU-PB
- Plug-on board ALLDAQ relay board ADQ-SCU-RB
- 2 x 68-pin VHDCI cable (male-male), double shielded, cables twisted in pairs, length: 1.2 m (ADQ-CR-VHDCI-68M/68M-1.2m), item no.: 150597 (2 x)
- HDMI cable, length: 1 m (ADQ-CR-HDMI-MM-1m), item no.: 127015

1.2 Safety instructions



Be sure to observe the following instructions:

- Avoid touching cables and connectors
- Never expose the device to direct sunlight during operation.
- Never operate the device near heat sources.
- Protect the device from moisture, dust, liquids and vapours.
- Do not use the device in damp rooms and under no circumstances in potentially explosive areas.
- Repairs may only be carried out by trained, authorised personnel.
- When commissioning the instrument, please observe the installation regulations and all relevant standards (including VDE standards), especially when operating with voltages higher than 42 V.

- We recommend to always connect unused inputs to the corresponding reference ground to avoid crosstalk between the input channels.
- Always disconnect the field wiring of the analog and digital inputs/outputs from the signal conditioning unit (ADQ-SCU incl. plug-in boards) as well as the connection to the ADQ-348 before connecting or disconnecting the power supply of the signal conditioning unit.
- Make sure that no static discharge can occur through the device when handling the card. Follow standard ESD protection measures.
- Never connect the devices to live parts, especially not to mains voltage.
- Precautions to avoid unpredictable misuse must be taken by the user.

ALLNET® GmbH Computersysteme is not liable for improper use and resulting damage.

1.3 Installation and assembly site

The signal conditioning unit (ADQ-SCU incl. plug-in boards) is intended for installation in measuring and test systems by qualified personnel. The relevant installation regulations and standards must be observed.

The ADQ-SCU may only be used in dry rooms. Ensure sufficient heat dissipation. Ensure that the connecting cables are securely attached. The installation must be carried out in such a way that the cables are not under tension, otherwise they may become loose.

1.4 Brief description

The ALLDAQ ADQ-SCU signal conditioning unit was developed to optimally adapt a large number of analog and digital inputs/outputs to the requirements of a complex, automated measurement and test system. Signals are acquired and generated synchronously via the multifunctional ALLDAQ ADQ-348 measurement and control card, which simultaneously controls the ADQ-SCU via I2C bus.

Important features:

- Analysis of audio signals of different levels
- Adjustable input coupling (AC/DC), digital filters, gain and attenuation
- Measurement and mathematical evaluation of relevant parameters
- Monitoring level for listening to all audio channels
- Generation of audio signals for stimulation of power amplifiers
- Switch supply voltages via relay, optional: ADQ-RB-16/8
- Switch currents up to 50 A (100 VDC) via relay, optional: ADQ-SCU-PB-50
- e.g. connect the supply voltage to the DUT
- Customer-specific extensions via plug-in modules
- Simple control via ALLDAQ driver system
- API for easy integration into your application
- Optimized for operation with the isolated ADQ-348 DAQ and control card

2. Overview of the system

2.1 Block diagram

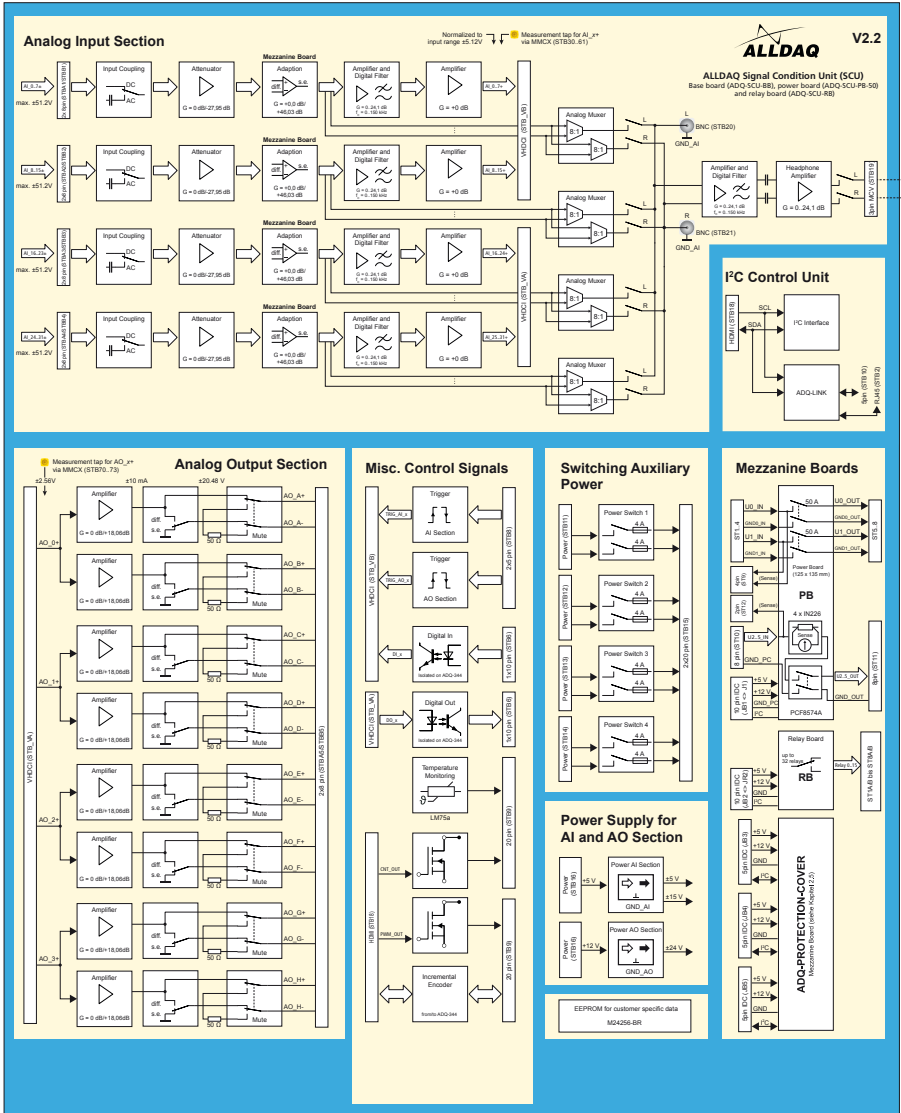

Fig. 1: Block diagram ADQ-SCU

2.2 Baseboard ADQ-SCU-BB

Baseboard for Signal Condition Unit (SCU) for connection to ADQ-348.

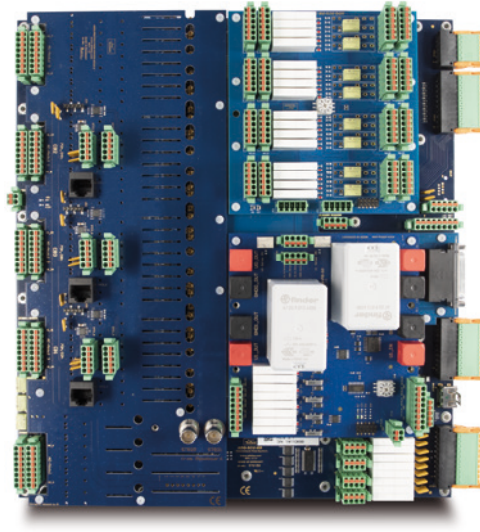

Fig. 2: Baseboard ADQ-SCU-BB

A/D section

- 32 analog inputs, input range per channel of ± 1 mVrms. ± 55 Vrms programmable
- AC/DC coupling programmable per channel
- -47.95 dB Attenuation level switchable per channel
- Digital filter stage programmable per channel
- (cut-off frequency adjustable from 0 to 150 kHz in steps of 10 kHz)
- Preamplifier Diff to SE (+0.0 dB/+46.03 dB) programmable/channel
- Gain per channel programmable (factor: 1..16, this corresponds to: 0..24.1 dB)
- Monitoring stage: Stereo headphone amplifier for direct connection of headphones
- 4 digital trigger inputs

D/A section

- 4/8 analog outputs, output range ± 2.56 Vp / ± 20.48 Vp, Iout = 50mA/N output channels (programmable gain/channel 0 dB/+18.06 dB)
- Switching per channel between reference to ground and common mode output
- Mute
- 4 digital trigger inputs

Other features

- Baseboard temperature monitoring with threshold value setting and opto-decoupled alarm output
- 3 male connector strips for ADQ protection cover (see chapter 2.5)
- PWM output (opto-decoupled)
- 1 x 32 bit counter up to 66 MHz (inputs: enable, ext. trigger, ext. clock, output: strobe)
- 8 isolated digital inputs
- 8 isolated digital outputs
- Complete control via I2C bus

2.3 Powerboard ADQ-SCU-PB-50

Powerboard for Signal Condition Unit (SCU) for plugging onto ADQ-SCU-BB.

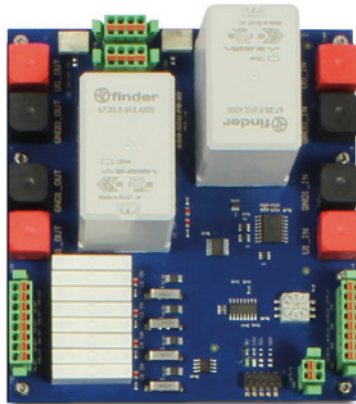

The board can be attached to the SCU with M3 screws with a torque of 0.5 Nm.

Caution: Higher torques can cause the mounting bolt on the SCU to shear.

Fig. 3: Powerboard ADQ-SCU-PB-50

- Power plug-in board (I2C controlled)
- 2 x high current relays up to max. 100 VDC/50 A per relay (sense line at relay input)
- 4 x supply (U2..5) switchable via relay max. 36 VDC/5 A per relay (sense line at relay input)
- 4-channel power measurement for U2..5
- Adjustable I2C addresses (eight possibilities)

2.4 Relay board ADQ-SCU-RB

Relay board for Signal Condition Unit (SCU) for plugging onto ADQ-SCU-BB.

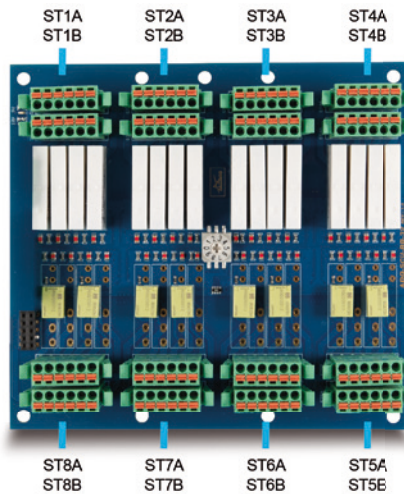

Fig. 4: Relay board ADQ-SCU-RB-16/8

- Other relay equipment possible
- Relay plug-in board (I2C controlled)
- 16 changeover relays (DPDT, type C), max. 30 VDC/6 A
- 8 small signal change-over relay (SPDT, type C), max. switching power 62.5VA/30W DC
- Contact resistance 1 A/6VDC max. 75mΩ at 1 A/6VDC

Other relay configurations are possible.

The board can be attached to the SCU with M3 screws with a torque of 0.5 Nm.

Caution: Higher torques can cause the mounting bolt on the SCU to shear.

2.5 ADQ-PROTECTION-COVER 2.0

Protection cover for ADQ-SCU-BB incl. 3x buffered I2C Bus (GEN2) /3x unbuffered I2C Bus
 ADQ-LINK (point to point):

- Overvoltage protection of the lines up to ± 60 V / slave devices can be placed up to 100 m (twisted cable)
- IEC Level 4 ESD ± 8 kV and EFT ± 5 kV
- Status LED (yellow), if connection to a slave device is available

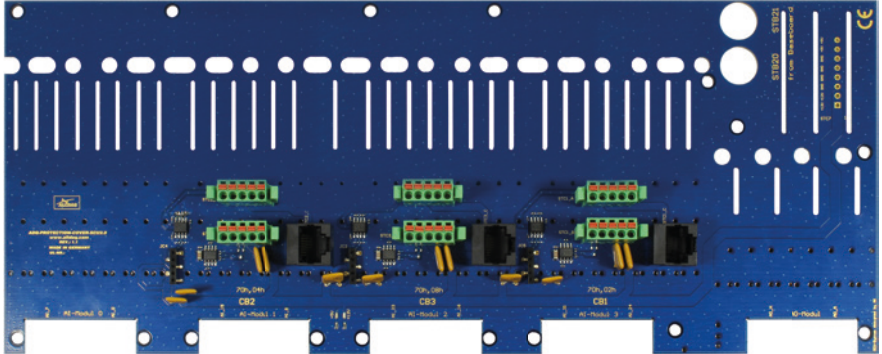

Fig. 5: ADQ-PROTECTION-COVER-SCU 2.0

Pin	STC3_(A) via JC3	STC2_(A) via JC4	STC1_(A) via JC5	Note
1	SCL	SCL	SCL	SCL
2	GND_PC	GND_PC	GND_PC	PC ground
3	+5V_PC	+5V_PC	+5V_PC	Protected by Polyfuse 16R 400g (littlefuse)
4	SDA	SDA	SDA	SDA
5	+12V_PC	+12V_PC	+12V_PC	Protected by Polyfuse 16R 400g (littlefuse)

I2C (TTL level)

Pin	STC3_(B) via JC3	STC2_(B) via JC4	STC1_(B) via JC5	Note
1	+ADQ-LINK	+ADQ-LINK	+ADQ-LINK	Differential BUS
2	GND_PC	GND_PC	GND_PC	PC ground
3	+5V_PC	+5V_PC	+5V_PC	Secured by Polyfuse 16R 500g (littlefuse)
4	-ADQ-LINK	-ADQ-LINK	-ADQ-LINK	Differential BUS
5	+12V_PC	+12V_PC	+12V_PC	Secured by Polyfuse 16R 500g (littlefuse)

Slave devices (e.g. ADQ-31, ADQ-48) can be connected via these connectors.

Note: Route the ADQ link via a simple **twisted pair cable**.

RJ-45 Pin assignment

Slave devices (e.g. ADQ-31, ADQ-48) can be connected via these connectors.

Pin	STC1_C	STC2_C	STC3_C	Note
1	+5V_PC	+5V_PC	+5V_PC	Secured by Polyfuse MF-USML175/12
2	+5V_PC	+5V_PC	+5V_PC	Secured by Polyfuse MF-USML175/12
3	+12V_PC	+12V_PC	+12V_PC	Secured by Polyfuse MF-USML175/12
4	+12V_PC	+12V_PC	+12V_PC	Secured by Polyfuse MF-USML175/12
5	GND_PC	GND_PC	GND_PC	PC ground pluggable via jumper
6	GND_PC	GND_PC	GND_PC	PC ground pluggable via jumper
7	-ADQ-LINK	-ADQ-LINK	-ADQ-LINK	Differential BUS
8	+ADQ-LINK	+ADQ-LINK	+ADQ-LINK	Differential BUS

The board can be attached to the SCU with M3 screws with a torque of 0.5 Nm.

Caution: Higher torques can cause the fastening bolt on the SCU to shear.

2.6 Multifunction card ADQ-348

The ADQ-SCU was developed for connection to the multifunctional ALLDAQ ADQ-348 measurement and control card, which simultaneously controls the ADQ-SCU via I2C bus. The connection is made via two 68-pin VHDCI cables and one HDMI cable for various special functions such as the I2C bus for controlling the ADQ-SCU.

The ADQ-348 provides the following basic functionality:

- 32 pseudo-differential 18 bit voltage inputs up to 800 kS/s
- Input ranges: ± 10.24 Vp, ± 5.12 Vp, 0-10.24 Vp, 0-5.12 Vp
- Insulation voltage A/D section: 1500 VDC (60 s)
- Four 16 bit voltage outputs (± 2.56 Vp) up to 500 kS/s
- Insulation voltage D/A section: 1500 VDC (60 s)
- 16 TTL-DIOs (3.3 V/5 V), max. 20 mA per output
- 8 isolated digital inputs (High: 15..35 V)
- 8 isolated digital outputs up to 600 mA/output
- Isolation voltage DI and DO part: 500 VAC
- Special functions via HDMI connector: 32 bit counter, I2C bus port, incremental encoder port, frequency measurement, PWM output

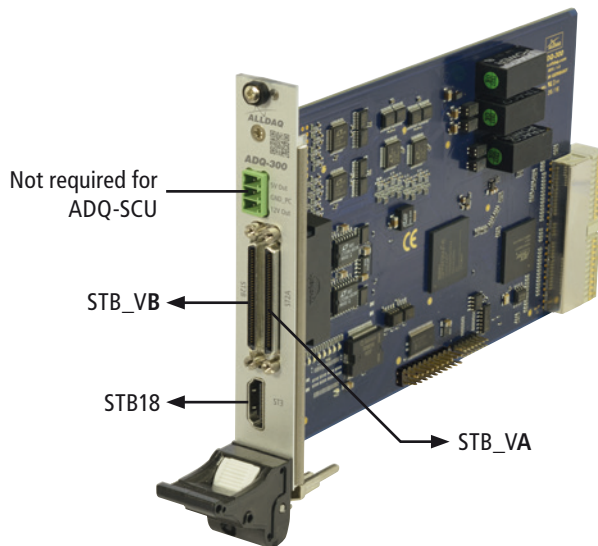

Fig. 6: Multifunction card ADQ-348

2.7 Example system configuration

Typical configuration from an ADQ-Express measurement system, equipped with 2 multifunction cards of type ADQ-348 to control one signal conditioning unit ADQ-SCU each. In addition, one current measurement channel of the ADQ-412 is connected to one ADQ-SCU-PB-50 power board per DUT.

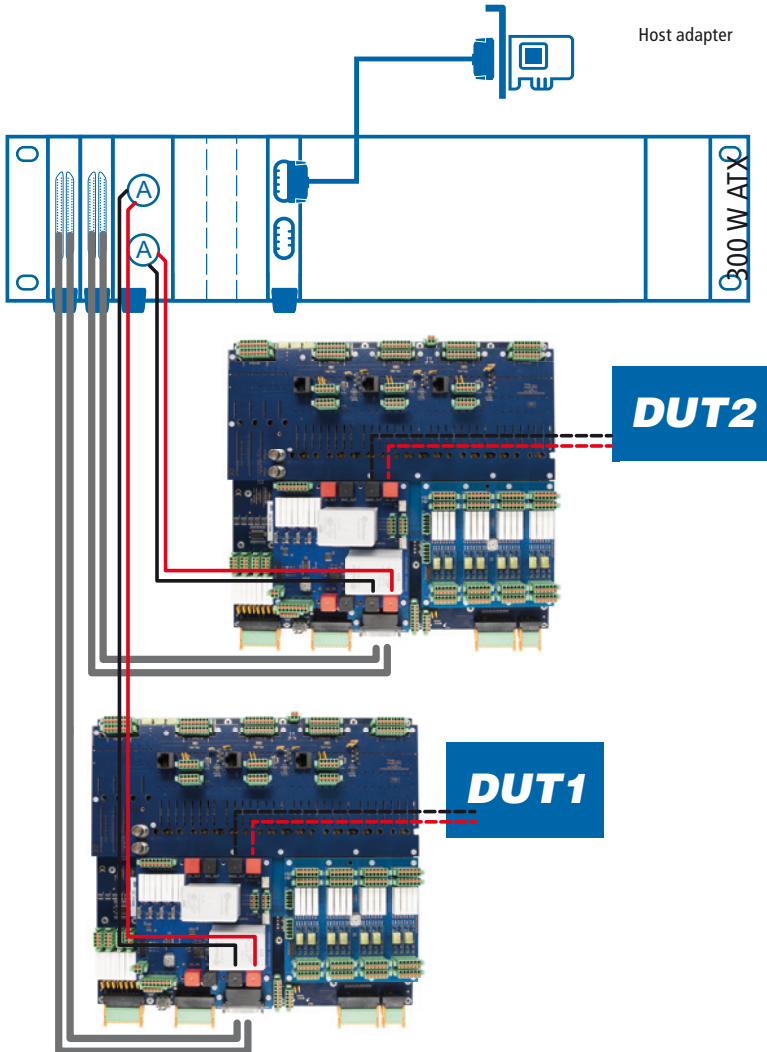

Fig. 7: Example system configuration

3. Pin assignments

3.1 Position of the connectors

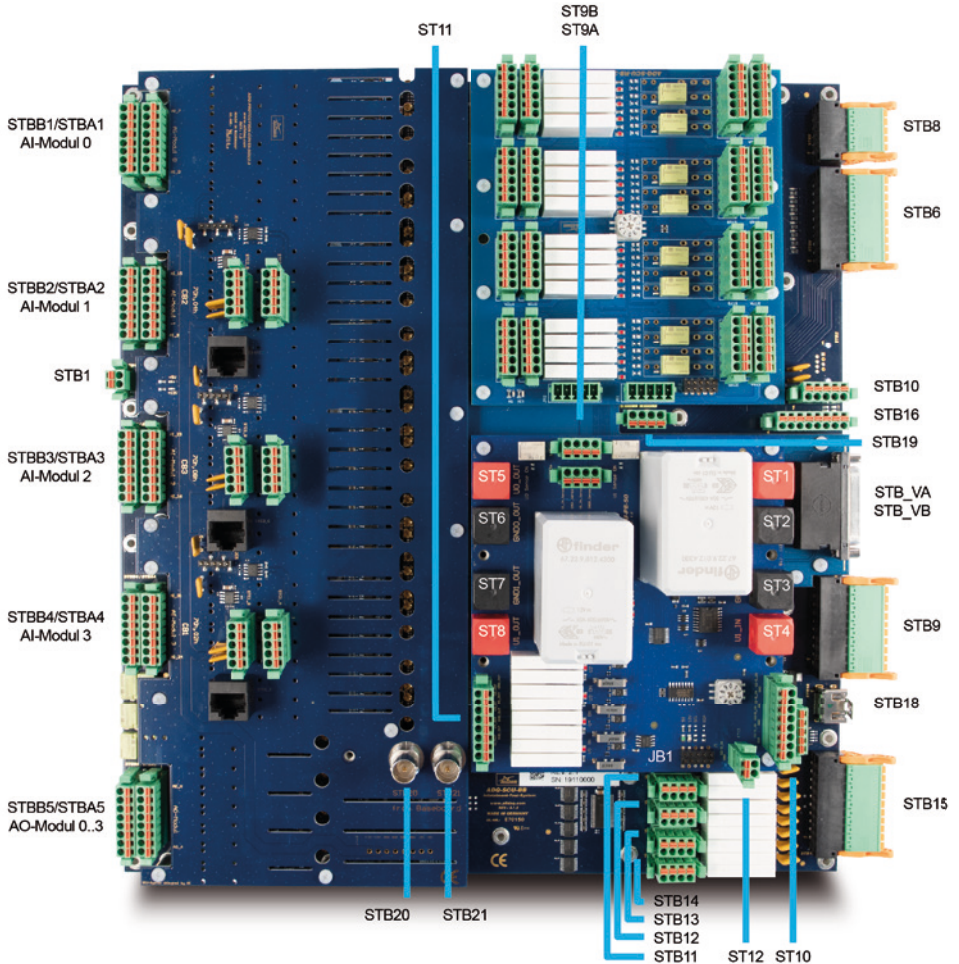

Fig. 8: Position of the connectors

3.2 Prefixes of the connector designations

STB: Connectors on the baseboard (ADQ-SCU-BB)

ST: Connectors on the powerboard (ADQ-SCU-PB-50)

STR: Connectors on the relay board (ADQ-SCU-RB)

Jx: Pin connector for connection from baseboard to plug-in boards

3.3 Overview of the connector types

3.3.1 Type Würth

Numerous connectors of the Würth 69130513... series with different numbers of pins are used.

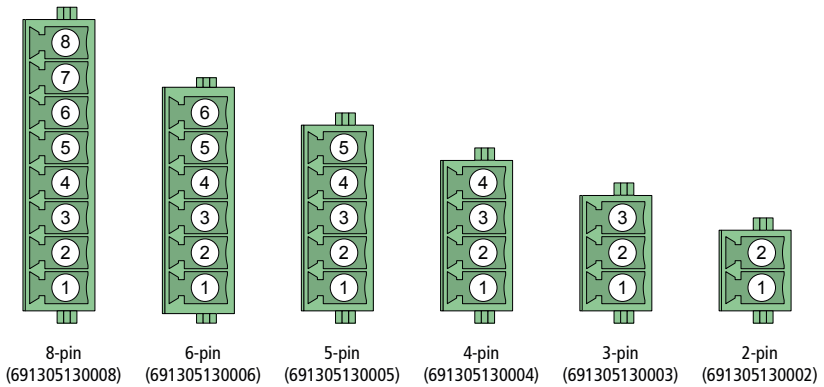
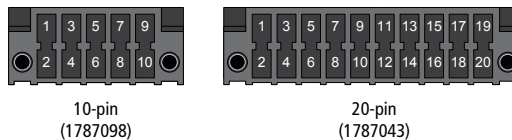

Fig. 9: Würth baseboard (top view)

3.3.2 Type Phoenix Contact



3.3.3 Type Pin plug

For the connection between baseboard and plug-on modules, 10- and 5-pin pin connectors are used (grid dimension: 2.54 mm).

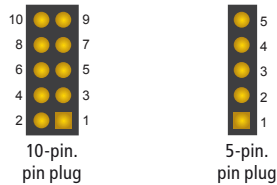

Fig. 10: Pin connectors (top view)

3.3.4 Type Würth

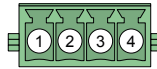

Fig. 11: 4-pin headphone connector (top view)
Plug type: 4-pin base strip, Würth (691305130004)

3.3.5 Mating connector for Würth connectors

We recommend the mating connector housing series 69130413-xy with UL 94V-2 approval.

Number of pins	Connector type on ADQ-SCU	Mating connector housing
2-pin	691305130002	691304130002
3-pin	691305130003	691304130003
4-pin	691305130004	691304130004
5-pin	691305130005	691304130005
8-pin	691305130008	691304130008

Chart 1: Overview mating connectors

3.3.6 Mating connector for Phoenix connectors

Number of pins	Connector type on ADQ-SCU	Mating connector housing
10-pin	1787098	1790564
20-pin	1787043	1790519

Chart 2: Overview mating connectors

3.4 Baseboard (ADQ-SCU-BB)

3.4.1 Analog input section (STBA1..4/STBB1..4)

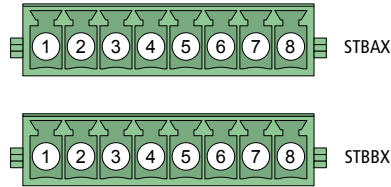

Figure 12: 8-pin Würth connector

The corresponding MMCX connectors (STB30..61) are given in brackets. They can be used as measuring taps for the analog input signals to the ADQ-348.

Pin	STBA1/STBB1 (module 0)	STBA2/STBB2 (module 1)	STBA3/STBB3 (module 2)	STBA4/STBB4 (module 3)
8	+AI0_M0 (STBA1)	+AI0_M1 (STBA2)	+AI0_M2 (STBA3)	+AI0_M3 (STBA4)
7	+AI1_M0 (STBA1)	+AI1_M1 (STBA2)	+AI1_M2 (STBA3)	+AI1_M3 (STBA4)
6	+AI2_M0 (STBA1)	+AI2_M1 (STBA2)	+AI2_M2 (STBA3)	+AI2_M3 (STBA4)
5	+AI3_M0 (STBA1)	+AI3_M1 (STBA2)	+AI3_M2 (STBA3)	+AI3_M3 (STBA4)
4	+AI4_M0 (STBA1)	+AI4_M1 (STBA2)	+AI4_M2 (STBA3)	+AI4_M3 (STBA4)
3	+AI5_M0 (STBA1)	+AI5_M1 (STBA2)	+AI5_M2 (STBA3)	+AI5_M3 (STBA4)
2	+AI6_M0 (STBA1)	+AI6_M1 (STBA2)	+AI6_M2 (STBA3)	+AI6_M3 (STBA4)
1	+AI7_M0 (STBA1)	+AI7_M1 (STBA2)	+AI7_M2 (STBA3)	+AI7_M3 (STBA4)
8	-AI0_M0 (STBB1)	-AI0_M1 (STBB2)	-AI0_M2 (STBB3)	-AI0_M3 (STBB4)
7	-AI1_M0 (STBB1)	-AI1_M1 (STBB2)	-AI1_M2 (STBB3)	-AI1_M3 (STBB4)
6	-AI2_M0 (STBB1)	-AI2_M1 (STBB2)	-AI2_M2 (STBB3)	-AI2_M3 (STBB4)
5	-AI3_M0 (STBB1)	-AI3_M1 (STBB2)	-AI3_M2 (STBB3)	-AI3_M3 (STBB4)
4	-AI4_M0 (STBB1)	-AI4_M1 (STBB2)	-AI4_M2 (STBB3)	-AI4_M3 (STBB4)
3	-AI5_M0 (STBB1)	-AI5_M1 (STBB2)	-AI5_M2 (STBB3)	-AI5_M3 (STBB4)
2	-AI6_M0 (STBB1)	-AI6_M1 (STBB2)	-AI6_M2 (STBB3)	-AI6_M3 (STBB4)
1	-AI7_M0 (STBB1)	-AI7_M1 (STBB2)	-AI7_M2 (STBB3)	-AI7_M3 (STBB4)

Table 3: Pin assignment STBA1-4/STBB1-4

AI module 0	AI_0 (STB30)... AI_7 (STB37)
AI module 1	AI_8 (STB38)... AI_15 (STB45)
AI module 2	AI_16 (STB46)... AI_23 (STB53)
AI module 3	AI_24 (STB54)... AI_31 (STB61)

Figure 13: MMCX plug STB30..61

3.4.2 Analog output section (STBA5/STBB5)

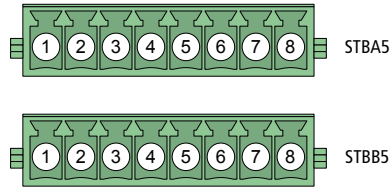

Figure 14: 8-pin Würth connector

Pin	STBA5/STBB5	Note
8	AO_A+ (STBA5)	Corresponding output signal from AO_0+
7	AO_B+ (STBA5)	Corresponding output signal from AO_0+
6	AO_C+ (STBA5)	Corresponding output signal from AO_1+
5	AO_D+ (STBA5)	Corresponding output signal from AO_1+
4	AO_E+ (STBA5)	Corresponding output signal from AO_2+
3	AO_F+ (STBA5)	Corresponding output signal from AO_2+
2	AO_G+ (STBA5)	Corresponding output signal from AO_3+
1	AO_H+ (STBA5)	Corresponding output signal from AO_3+
8	AO_A- (STBB5)	Alternatively in-phase to AO_A+ or reference to GND_AO
7	AO_B- (STBB5)	Alternatively in-phase to AO_B+ or reference to GND_AO
6	AO_C- (STBB5)	Alternatively in-phase to AO_C+ or reference to GND_AO
5	AO_D- (STBB5)	Alternatively in-phase to AO_D+ or reference to GND_AO
4	AO_E- (STBB5)	Alternatively in-phase to AO_E+ or reference to GND_AO
3	AO_F- (STBB5)	Alternatively in-phase to AO_F+ or reference to GND_AO
2	AO_G- (STBB5)	Alternatively in-phase to AO_G+ or reference to GND_AO
1	AO_H- (STBB5)	Alternatively in-phase to AO_H+ or reference to GND_AO

Chart 4: Pin assignment STBA5/STBB5

Corresponding MMCX coaxial connectors (STB70..73) that can be used as measuring taps for the analog output signals from the ADQ-348.

AO module 0	AO_0+ from ADQ-348 (STB70)
AO module 1	AO_1+ from ADQ-348 (STB71)
AO module 2	AO_2+ from ADQ-348 (STB72)
AO module 3	AO_3+ from ADQ-348 (STB73)

Fig. 15: MMCX plug STB70..73

3.4.3 Digital I/O section (STB6)

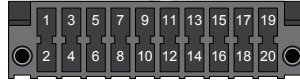

Fig. 16: 20-pin Phoenix connector

Pin	STB6 (DO)	Pin	STB6 (DI)
1	V_EXT_DO	11	GND_DI
2	GND_DO	12	V_EXT_DI
3	DO_0	13	DI_0
4	DO_1	14	DI_1
5	DO_2	15	DI_2
6	DO_3	16	DI_3
7	DO_4	17	DI_4
8	DO_5	18	DI_5
9	DO_6	19	DI_6
10	DO_7	20	DI_7

Chart 5: Pin assignment STB6

3.4.4 External trigger inputs for AI/AO part (STB8)



Fig. 17: 10-pin Phoenix connector

Pin	STB8	Note
1	TRIG_AO_1	Trigger input for analog output AO_1 of ADQ-348 (= AO_C/D)
2	TRIG_AO_0	Trigger input for analog output AO_0 of ADQ-348 (= AO_A/B)
3	TRIG_AO_3	Trigger input for analog output AO_3 of ADQ-348 (= AO_G/H)
4	TRIG_AO_2	Trigger input for analog output AO_2 of ADQ-348 (= AO_E/F)
5	TRIG_AO_GND	Reference ground for triggering the analog outputs
6	TRIG_AI_GND	Reference ground for triggering the analog outputs
7	TRIG_AI_2	Trigger input for analog input module AI_2 of ADQ-348 (= AI_16..23)
8	TRIG_AI_3	Trigger input for analog input module AI_3 of ADQ-348 (= AI_24..31)
9	TRIG_AI_0	Trigger input for analog input module AI_0 of ADQ-348 (= AI_0..7)
10	TRIG_AI_1	Trigger input for analog input module 1 of ADQ-348 (= AI_8..15)

Chart 6: Pin assignment STB8

3.4.5 Counter, ignition signal & temperature alarm (STB9)

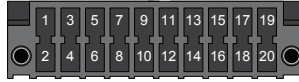

Fig. 18: 20-pin Phoenix connector

Pin	STB9	Note
1	TEMP_OUT	Open collector output of temperature monitoring on the baseboard ($V_{CE} = 50\text{ V} / I_{max.} = 250\text{ mA}$)
2	VCC_PC	+5 V from PC
3	PWM_OUT	SINK output: square wave signal with variable duty cycle
4	GND_PC	PC ground
5	32 bit Zähler	SINK output: strobe (see ADQ-344 documentation)
6	GND_PC	PC ground
7	FRQ_IN	Input for frequency measurement
8	GND_PC	PC ground
9	INC_A	Incremental encoder input (channel A)
10	GND_PC	PC ground
11	INC_B	Incremental encoder input (channel B)
12	GND_PC	PC ground
13	INC_EXT_RST	Incremental encoder reset input
14	GND_PC	PC ground
15	PWM_EN	Enable input for PWM output
16	GND_PC	PC ground
17	CNT_EN	Enable input for counter
18	GND_PC	PC ground
19	CNT_TRIG	External trigger input for counter
20	CNT_EXT_CLK	External clock input for counter

Chart 7: Pin assignment STB9

3.4.6 Pin assignment (STB10_A)

The TTL I2C bus (5V level) is connected to this connector.

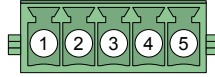

Fig. 19: 5-pin Würth connector

Pin	STB10_A	Note
1	SCL	Buffered SCL
2	GND_PC	PC ground
3	+5V_PC	Protected by Polyfuse 16R 400g (littlefuse)
4	SDA	Buffered SDA
5	+12V_PC	Protected by Polyfuse 16R 400g (littlefuse)

Chart 8: Pin assignment STB10_A

3.4.7 Special functions (STB10_B)

The ADQ-SCU-LC can be remotely controlled via these connectors. For further information please contact the ALLDAQ Support.

ADQ-LINK (point to point):

- Overvoltage protection of the lines up to ± 60 V / slave devices can be placed up to 100 m (twisted cable)
- IEC Level 4 ESD ± 8 kV and EFT ± 5 kV
- Status LED (yellow), if connection to a slave device is available

Pin	STB10_B	Note
1	+ADQ-LINK	Differential BUS
2	GND_PC	PC ground
3	+5V_PC	Secured by Polyfuse 16R 500g (littlefuse)
4	-ADQ-LINK	Differential BUS
5	+12V_PC	Secured by Polyfuse 16R 500g (littlefuse)

Note: ADQ-Link via simple **twisted pair** cabel.

RJ-45 Pin assignment

The ADQ-SCU-BB can be remotely controlled via these connectors.

Pin	STB2	Note
1	+5V_PC	Secured by Polyfuse MF-USML175/12
2	+5V_PC	Secured by Polyfuse MF-USML175/12
3	+12V_PC	Secured by Polyfuse MF-USML175/12
4	+12V_PC	Secured by Polyfuse MF-USML175/12
5	GND_PC	PC ground pluggable via jumper
6	GND_PC	PC ground pluggable via jumper
7	-ADQ-LINK	Differential BUS
8	+ADQ-LINK	Differential BUS

3.4.8 Switchable auxiliary voltages (STB11..14 > STB15)

Power supply via four Würth connectors (STB11..14). Pins 1 and 4 are output via a relay contact on STB15.

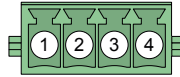

Fig. 20: 4 x 4-pin Würth pin connector (STB11..14)

Pin	STB11 (Switch 1)	STB12 (Switch 2)	STB13 (Switch 3)	STB14 (Switch 4)
1	U0_AUX_IN	U2_AUX_IN	U4_AUX_IN	U6_AUX_IN
2	GND_AUX_0	GND_AUX_1	GND_AUX_2	GND_AUX_3
3	GND_AUX_0	GND_AUX_1	GND_AUX_2	GND_AUX_3
4	U1_AUX_IN	U3_AUX_IN	U5_AUX_IN	U7_AUX_IN

Chart 9: Pin assignment STB11..14

Pins 1 and 4, via the four Würth connectors (STB11..14) are output to STB15 via a relay contact. Each output is protected by a 4 A Polyfuse fuse.

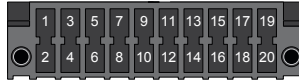

Fig. 21: 20-pin Phoenix connector (STB15)

Pin	STB15	Note
1	U7_AUX_OUT	Relay switches U7_AUX_IN to U7_AUX_OUT (fused with polyfuse 16R 400g)
2	GND_AUX_3	GND_AUX_3_Ground
3	U6_AUX_OUT	Relay switches U6_AUX_IN to U6_AUX_OUT (fused with polyfuse 16R 400g)
4	GND_AUX_3	GND_AUX_3_Ground
5	U5_AUX_OUT	Relay switches U5_AUX_IN to U5_AUX_OUT (fused with polyfuse 16R 400g)
6	GND_AUX_2	GND_AUX_2_Ground
7	U4_AUX_OUT	Relay switches U4_AUX_IN to U4_AUX_OUT (fused with polyfuse 16R 400g)
8	GND_AUX_2	GND_AUX_2_Ground
9	NC	Not connected
10	NC	Not connected
11	NC	Not connected
12	NC	Not connected
13	U3_AUX_OUT	Relay switches U3_AUX_IN to U3_AUX_OUT (fused with polyfuse 16R 400g)
14	GND_AUX_1	GND_AUX_1_Ground
15	U2_AUX_OUT	Relay switches U2_AUX_IN to U2_AUX_OUT (fused with polyfuse 16R 400g)
16	GND_AUX_1	GND_AUX_1_Ground
17	U1_AUX_OUT	Relay switches U1_AUX_IN to U1_AUX_OUT (fused with polyfuse 16R 400g)
18	GND_AUX_0	GND_AUX_0_Ground
19	U0_AUX_OUT	Relay switches U0_AUX_IN to U0_AUX_OUT (fused with polyfuse 16R 400g)
20	GND_AUX_0	GND_AUX_0_Ground

Chart 10: Pin assignment STB15

3.4.9 Supply for baseboard (STB16)

Power supply from PC power supply unit via a Würth connector (STB16) for power supply baseboard, powerboard and relay board with ± 5 V, ± 15 V and ± 24 V.

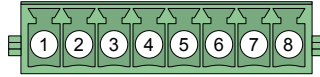

Fig. 22: 8-pin Würth connector (STB16)

Pin	STB16
1	12V_IN (+12V PC)
2	12V_IN (+12V PC)
3	GND_PC
4	GND_PC
5	GND_PC
6	GND_PC
7	5V_IN (+5V PC)
8	5V_IN (+5V PC)

Chart 11: Pin assignment STB16

3.4.10 HDMI connectors for special functions (STB18)

HDMI connector for connecting the following special functions of the ADQ-348 (ST3) to the baseboard:

- 32 bit counter (prefix: CNT...)
- I2C bus port (prefix: I2C..)
- Incremental encoder port (prefix: INC...)
- Frequency measurement input (prefix: FRQ...)
- PWM output (prefix: PWM...)

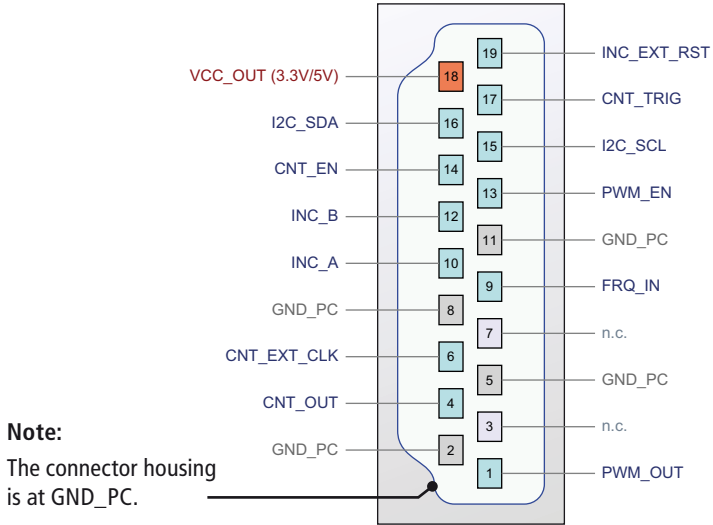

Fig. 23: HDMI connectors (STB18)

Pin	STB18	Note
1	PWM_OUT	Input for PWM output of ADQ-348
2	GND_PC	PC ground
3	n.c.	reserved
4	CNT_OUT	Input for strobe output of the ADQ-348 counter
5	GND_PC	PC ground
6	CNT_EXT_CLK	Output to external clock input for ADQ-348 counter
7	n.c.	reserved
8	GND_PC	PC ground
9	FRQ_IN	Output to frequency measurement input of ADQ-348
10	INC_A	Output to incremental encoder input (channel A) of ADQ-348
11	GND_PC	PC ground
12	INC_B	Output to incremental encoder input (channel B) of ADQ-348
13	PWM_EN	Output to enable input for PWM output of the ADQ-348
14	CNT_EN	Output to enable input for ADQ-348 counter
15	I2C_SCL	Clock input for I2C bus from the ADQ-348
16	I2C_SDA	Data input for I2C bus from the ADQ-348
17	CNT_TRIG	Output to external trigger input for ADQ-348 counter
18	VCC_IN_344	3.3 V/5 V supply voltage of ADQ-348
19	INC_EXT_RST	Output to incremental encoder Reset input of ADQ-348

Chart 12: Pin assignment STB18

3.4.11 Audio output (STB19)

Stereo audio output for connecting headphones. The output is relay-switchable so that the audio outputs of several baseboards can be wired in parallel.

Caution:

In case of parallel connection of audio outputs of several baseboards, you must ensure that two or more outputs are never active at the same time (relay closed). Otherwise the output stage can be destroyed.

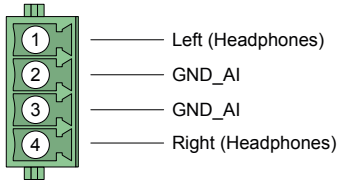

Fig. 24: Audio output (STB19)

Connector type: 4-pin Würth base strip

Suitable mating connector with spring terminals: 691304130004

3.4.12 Measurement signal tap (STB20..21)

Measuring signal tap between digital filter stage and output amplifier. By appropriate control of the analog multiplexer stage and the downstream relays, each of the 32 A/D channels can be switched to any of the two BNC sockets.

Note:

Always switch only one A/D channel to a specific BNC socket!

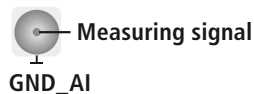

Fig. 25: 2 x BNC socket (STB20..21)

3.4.13 Analog AI-GND (AGND) STB1

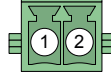

Fig. 26: 1 x 2-pin Würth plug connector

Pin	STB1	Note
1	AGND	AI_GND (AI0..3 module)
2	AGND	AI_GND (AI0..3 module)

3.4.14 68-pin VHDCI sockets from/to ADQ-34x (STB_VA/B)

The following pin assignment refers to the VHDCI sockets on the ADQ-348, i.e. the direction of the signals on the baseboard side is inverted.

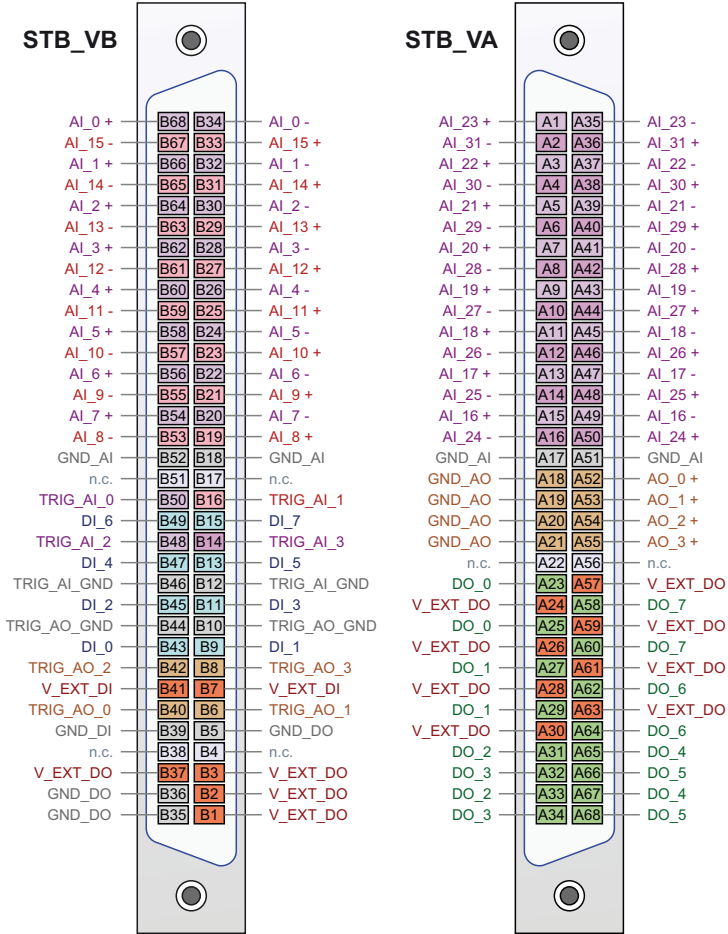

Fig. 27: Pin assignment STB_VA and STB_VB

3.5 Powerboard (ADQ-SCU-PB)

3.5.1 Pin connector strip JB1 -> J1

The powerboard is connected to the baseboard via the two-row pin header JB1 -> J1.

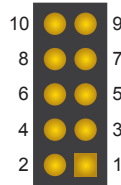

Fig. 28: 10-pin pin connector strip (JB1 / J1)

Pin	Note	Pin	Note
1	GND_PC	2	GND_PC
3	SCL_BASE	4	SDA_BASE
5	GND_PC	6	GND_PC
7	+12V PC	8	+12V PC
9	+5V PC	10	+5V PC

Chart 13: Pin assignment JB1/J1

3.5.2 High current supply switchable (ST1..8)

Via ST1..8 two power supplies up to max. 50 A/100 VDC per channel can be switched via relay. The switching status is indicated by an LED.

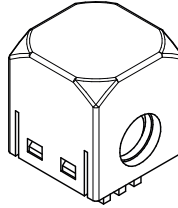

Fig. 29: 8 x single pole high current connectors of the type: Würth Electronic REDCUBE Direct Plug Terminal WP-PLUG.

ST..		Note
ST1	U0_IN	Input U0 _{IN}
ST2	GND0_IN	Input GND0 _{IN}
ST3	GND1_IN	Input GND1 _{IN}
ST4	U1_IN	Input U1 _{IN}
ST5	U0_OUT	Relay output U0 _{OUT}
ST6	GND0_OUT	Relay output GND0 _{OUT}
ST7	GND1_OUT	Relay output GND1 _{OUT}
ST8	U1_OUT	Relay output U1 _{OUT}

Chart 14: Pin assignment ST1..8

3.5.3 Sense connection (ST9)

Sense connection to monitor the voltage at the inputs U0_{IN} and U1_{IN} .

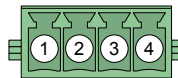

Fig. 30: 4-pin Würth plug connector

Pin	ST9	Note
1	GND0_SENSE	Sense connection for GND0 _{IN} (coming from ST2)
2	U0_IN_SENSE	Sense connection for U0 _{IN} (coming from ST1)
3	GND1_SENSE	Sense connection for GND1 _{IN} (coming from ST3)
4	U1_IN_SENSE	Sense connection for U1 _{IN} (coming from ST4)

Chart 15: Pin assignment ST9

3.5.4 Supply switchable (ST10, ST11)

Via ST10 and ST11 four power supplies (max. 36 V/5 A per channel) can be switched via relay. The switching status is indicated by an LED. Voltage and current can be measured per channel (via 20 mΩ shunt). With the I2C power monitor type INA226, the power can be called up directly in addition to voltage (up to 36 VDC) and current (up to 5 A).

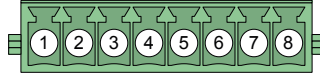

Fig. 31: 8-pin Würth connector (ST10, ST11)

Pin	ST10	ST11	Note
1	GND_PC	GND_OUT	PC ground
2	U2..5_IN	U2_OUT	Relay switches U2..5_IN to U2_OUT
3	GND_PC	GND_OUT	PC ground
4	U2..5_IN	U3_OUT	Relay switches U2..5_IN to U3_OUT
5	GND_PC	GND_OUT	PC ground
6	U2..5_IN	U4_OUT	Relay switches U2..5_IN to U4_OUT
7	GND_PC	GND_OUT	PC ground
8	U2..5_IN	U5_OUT	Relay switches U2..5_IN to U5_OUT

Chart 16: Pin assignment ST10, ST11

3.5.5 Sense connection (ST12)

Sense connection to monitor the voltage U_IN (see ST10).

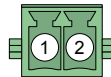

Fig. 32: 2-pin Würth connector

Pin	ST12	Note
1	GND_PC	PC ground
2	U2..5_IN	Sense connection for U2..5IN (coming from ST10)

Chart 17: Pin assignment ST12

3.6 Relay board (ADQ-SCU-RB)

3.6.1 Pin connector strip JB2 -> JR2

The relay board is connected to the baseboard via the two-row pin header JB2 -> JR2. 24 TTL I/O channels (DIO_0..23) and 16 single-pin changeover relays (SPDT, type C) are available.

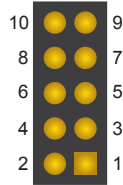

Fig. 33: 10-pin pin connector strip (JB2 / JR2)

Pin	Note	Pin	Note
1	GND_PC	2	GND_PC
3	SCL_BASE	4	SDA_BASE
5	GND_PC	6	GND_PC
7	+12V_PC	8	+12V_PC
9	+5V_PC	10	+5V_PC

Chart 18: Pin assignment JB2/JR2

3.6.2 Changeover relay (ST1A/ST1B..ST8A/ST8B)

Connections of the 16 changeover contact relays. All switching contacts (NO/NC/COM) are connected to the connectors ST1A/ST1B..ST8A/ST8B. Load capacity per relay (max. 30 VDC/6 A).

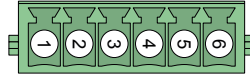

Fig. 34: 6-pin Würth connector

Pin	ST1A	ST1B	ST2A	ST2B	ST3A	ST3B	ST4A	ST4B
1	NO0	NO1	NO4	NO5	NO8	NO9	NO12	NO13
2	COM0	COM1	COM4	COM5	COM8	COM9	COM12	COM13
3	NC0	NC1	NC4	NC5	NC8	NC9	NC12	NC13
4	NO3	NO2	NO7	NO6	NO11	NO10	NO15	NO14
5	COM3	COM2	COM7	COM6	COM11	COM10	COM15	COM14
6	NC3	NC2	NC7	NC6	NC11	NC10	NC15	NC14

Pin	ST5A	ST5B	ST6A	ST6B	ST7A	ST7B	ST8A	ST8B
1	NO16	NO17	NO20	NO21	NO24	NO25	NO28	NO29
2	COM16	COM17	COM20	COM21	COM24	COM25	COM28	COM29
3	NC16	NC17	NC20	NC21	NC24	NC25	NC28	NC29
4	NO19	NO18	NO23	NO22	NO27	NO26	NO31	NO30
5	COM19	COM18	COM23	COM22	COM27	COM26	COM31	COM30
6	NC19	NC18	NC23	NC22	NC27	NC26	NC31	NC30

Chart 19: (ST1A/ST1B..ST8A/ST8B)

Note: Corresponding with the software, the index of the relays starts at "0".

3.7 Customer specific plug-in boards (CB1..3)

Three customer-specific plug-in boards (CB1..3) can be connected to the baseboard via the single-row pin headers JB3..5.

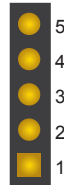

Fig. 35: 3 x 5-pin Pin connector strip (JB3..5)

Pin	JB3 (CB1)	JB4 (CB2)	JB5 (CB3)
1	GND_PC	GND_PC	GND_PC
2	SCL_CB1	SCL_CB2	SCL_CB3
3	SDA_CB1	SDA_CB2	SDA_CB3
4	+12V_PC	+12V_PC	+12V_PC
5	+5V_PC	+5V_PC	+5V_PC

Chart 20: Pin assignment JB3..5

4. ADQ-SCU 2.2 BB App

To learn how to operate the SCU, there is an app in the ALLDAQ Launcher under "Tools": "I2C Board Control Center".

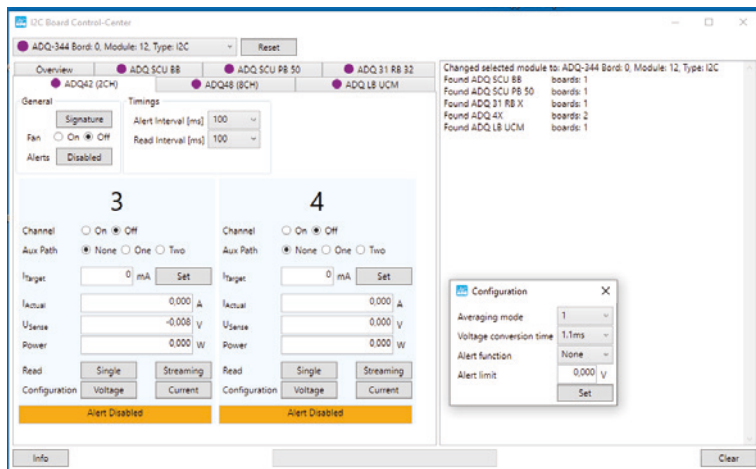
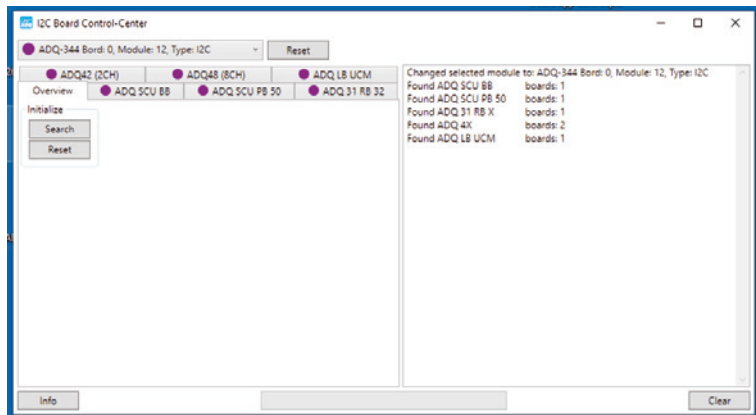

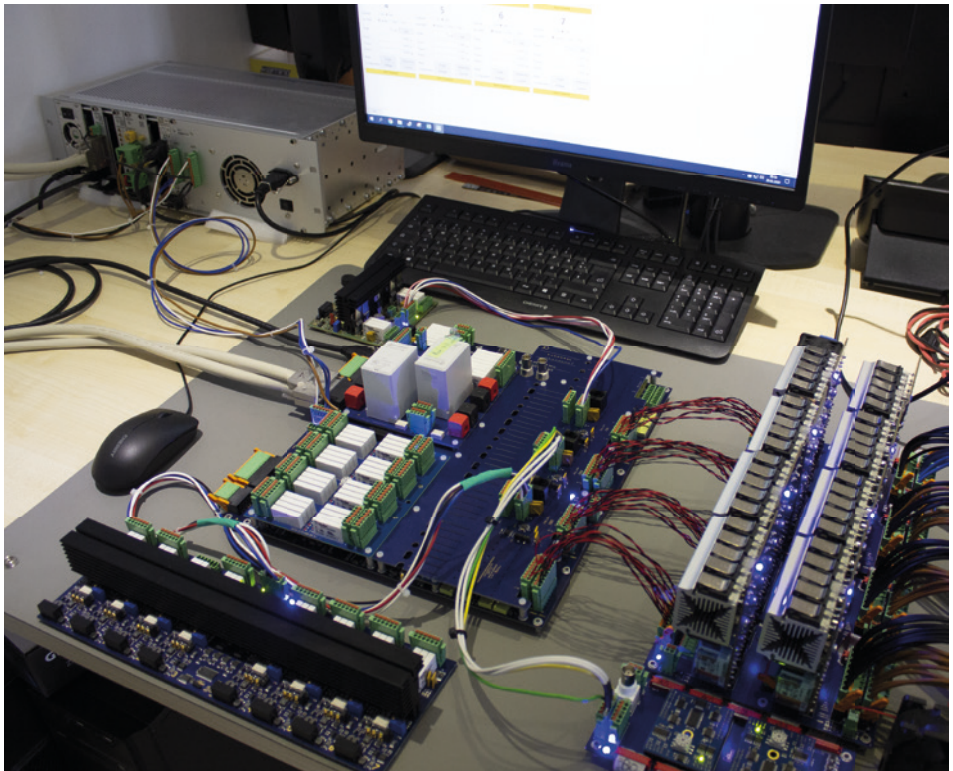

5. Monitoring stage with headphone amplifier

Each AI channel can be switched to the MAX9723 stereo headphone amplifier. You can freely select which of the channels is to be switched to the left or right channel of the MAX9723. You can connect the headphones directly to the output of the MAX9723.

See also data sheet under:

<https://www.maximintegrated.com/en/products/analog/audio/MAX9723.html>

6. Specifications

Conditions: $T_A = 25^\circ\text{C}$ unless otherwise stated; warm-up time: 30 minutes.

General

Element	Condition	Specification
Control and signal processing	recommended	ADQ-348 for analog and digital input/output, and control via I2C-Bus
Supply	STB16	+5 V / +12 V supply via Würth connector from PC power supply unit for power supply of ADQ-SCU-BB/PB-50/RB with $\pm 5\text{ V}$, $\pm 15\text{ V}$, $\pm 24\text{ V}$, ± 10
Auxiliary voltages (switchable)	STB11..STB15	Power supply via four Würth connectors. Via relay switched to STB15 (Phoenix connector)
Quiescent current consumption	ADQ-SCU-BB/PB/RB no relay energized	+5V: max. 75 mA +12V: max. 1.4 A
Power consumption	ADQ-SCU-BB all relays energized	+5V: max. 75 mA +12V: max. 2.8 A
	ADQ-SCU-PB-50 all relays energized	+5V: max. 60 mA +12V: max. 280 mA
	ADQ-SCU-RB all relays energized	+5V: max. 60 mA +12V: max. 350 mA
Fuses for switchable auxiliary voltages via STB15	+5 V (F2, F4, F6, F8)	4A (self-healing, type: Polyfuse)
	+12 V (F1, F3, F5, F7)	4A (self-healing, type: Polyfuse)
Temperature range	Operation	0..60 °C (standard)
Humidity	Operation	20%..55% (non-condensing)
Dimensions (W x D x H)	ADQ-SCU-BB	330 x 300 x 50 mm
	ADQ-SCU-PB	135 x 125 x 65 mm
	ADQ-SCU-RB	135 x 125 x 19 mm
	Total amount	80 mm
Manufacturer Warranty		36 months

Element	Condition	Specification
Connections	STBA1..STBA4 STBB1..STBB4 STBA5/STBB5	8-pin Würth pin: 691305130008 Mating connector: 691304130008
	STB6/STB9/STB15	(2x10p.) 20-pin Phoenix connector: 1787043 Mating connector: 1790519
	STB16	8-pin Würth pin: 691305130008 Mating connector for power supply: 691304130008
	STB8	(2x5p.) 10-pin Phoenix connector (Trigger ADQ-348): 1787098; Mating connector: 1790564
	STB18	HDMI connectors, type HEC
	STB19	4-pin Würth pin: 691305130004 Mating connector: 691304130004
	STB10	5-pin Würth pin (buffered I2C): 691305130005
	STB20..21	Mating connector: 691304130005
	STB30..61, STB70..73	MMCX sockets
	STB_VA, STB_VB	Two 68-pin VHDCI sockets
	STR1..4*	12-pin Würth pin: 43045-1226 Mating connector: 43025-1210
	STR5..7*	10-pin Würth pin: 43045-1026 Mating connector: 43025-1010
	ST1..8	Single pole high current connectors of the type: Würth Electronic REDCUBE Direct Plug Terminal WP-PLUG (4 x black, 4 x red)
	STB11..STB14	4-pin Würth pin (auxiliary voltage): 691305130004 Mating connector: 691304130004
	ST9 ST9A/ST9B	4-pin Würth pin: 691305130004 Mating connector: 691304130004
	ST12	2-pin Würth pin (AGND): 691305130002 Mating connector: 691304130002
	ST10, ST11	8-pin Würth pin: 691305130008 Mating connector: 691304130008
	JB1..2, JR2_S	10-pin pin strip (double row)
JB3..5	5-pin pin strip (single row)	

*See also section "3.3 Overview of connector types" on page 18.

Analog inputs ADQ-SCU-BB

Unless otherwise specified here, the specifications of the ADQ-348 apply.

Basically, an adjustment with field wiring connected should be carried out in conjunction with the ADQ-348.

Element	Condition	Specification
Channels		32 single-ended analog inputs (4 AI modules)
Resolution		18 bit A/D converter resolution, the output level to ADQ-348 is normalized to ± 5.12 V
Input impedance	with damping	100K 6 k Ω 220pF
	without damping	100K 1 M Ω 220 pF
Input coupling		AC/DC (programmable)
Input attenuation		0 dB/-47.95 dB (programmable)
Preamplifier Diff to SE	AD8429	+12.04 dB/+33.85 dB (programmable)
Digital filter stage	LTC1564	0..150 kHz programmable in steps of 10 kHz; 100 dB attenuation at 2.5 times cut-off frequency
Amplifier stage	LTC1564	Factor 1..16 programmable (corresponds to 0 dB..24.1 dB)
Amplifier stage (cable)	OPA1612	0 dB (fix)
Sensible input voltage ranges	D = 0 dB, V = 4	0..(100 mV - 1 LSB), 1 LSB = 0.4 μ V
	D = 0 dB, V = 4	0..(500 mV - 1 LSB), 1 LSB = 1.94 μ V
	D = 0 dB, V = 1	0..(700 mV - 1 LSB), 1 LSB = 2.7 μ V
	D = -47,95 dB, V = 50	0..(5 V - 1 LSB), 1 LSB = 19 μ V
	D = -47,95 dB, V = 4	0..(25 V - 1 LSB), 1 LSB = 95.4 μ V
	D = -47,95 dB, V = 4	0..(51.2 V - 1 LSB), 1 LSB = 195 μ V
Rise time	AD8429	typ. >22 V/ μ s
	OPA1612	typ. >27 V/ μ s
	LTC1564	no manufacturer specification
	OPA1612	± 4 μ V/ $^{\circ}$ C
Small signal relay	See separate table for details	Type: FTR-B3CA(I)Z, up to 5 relays in AI signal path
Trigger inputs		4 external trigger inputs via STB8 (one per AI module)
Ground reference	Analog inputs	GND_AI
	AI Trigger Inputs	TRIG_AI_GND

Accuracy of the overall setup of ADQ-SCU signal conditioning unit and ADQ-348 multifunction measurement and control card:

Before starting the adjustment of the AI and AO part, the measuring system should warm up for at least 30 minutes. The following measuring equipment was used for the measurements:

- Reference voltage source: Kink J152
- 5½ digit multimeter: Siglent SDM3055
- ADQ-348 with the following settings: Sampling rate: 200 kHz, 5,000,000 values per channel, input range: ±5.12 V. The ADQ-348 is calibrated.

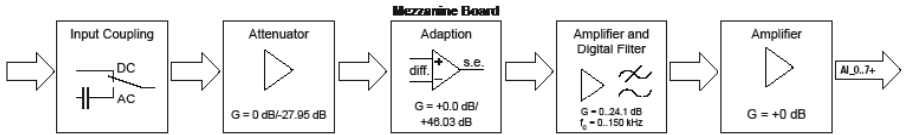

Input voltage	DC/AC	Damping	Adjustment	Amplifier/Filter	Reinforce-ment	Error
±10mV	DC	0 dB	G = 4	G = 16 / 20 kHz	36.12 dB	±0.0103%
±90mV	DC	0 dB	G = 4	G = 8 / 20 kHz	30.10 dB	±0.0072%
±200mV	DC	0 dB	G = 4	G = 4 / 20 kHz	12.04 dB	±0.0065%
±500mV	DC	0 dB	G = 4	G = 4 / 20 kHz	12.04 dB	±0.0065%
±1V	DC	-47.95 dB	G = 50	G = 1 / 20 kHz	33.85 dB	±0.15%
±10V	DC	-47.95 dB	G = 50	G = 1 / 20 kHz	33.85 dB	±0.08%
±19V	DC	-47.95 dB	G = 50	G = 1 / 20 kHz	33.85 dB	±0.021%

Audio-Monitoring-Stufe ADQ-SCU-BB

Element	Condition	Specification
Channels		1 x stereo audio output for connecting headphones
Digital filter stage	LTC1564	0..150 kHz programmable in steps of 10 kHz; 100 dB attenuation at 2.5 times cut-off frequency
Amplifier stage	LTC1564	Factor 1..16 programmable (corresponds to 0 dB..24.1 dB)
Output amplifier	MAX9723	0 dB..24.1 dB (programmable)
Connection	STB19	3-pin Würth pin: 691305130003 pin strip: 691304130003

Analogue outputs ADQ-SCU-BB

Unless otherwise specified here, the specifications of the ADQ-348 apply. As a rule, an adjustment should always be carried out in conjunction with the ADQ-348 when the field wiring is connected.

Element	Condition	Specification
Number of channels	AO_A..G±	8 single-ended/diff. Voltage outputs; 2 channels each (AO_x/y±) are fed from the same D/A channel of the ADQ-348
Output voltage range		-20.48V..(+20.48V - 1 LSB)
Resolution		16 bit (1 LSB = 625 µV)
Offset error	not aligned	max. 1.25 mV
Output current		max. ±10 mA per channel
Cut-off frequency		1 MHz (-3 dB)
Rise time		min. 18V/µs
Output impedance	switched off	>10 MΩ
Total accuracy		2 LSB = 1.25 mV
Channel shutdown		The output channel can be switched off by suitable programming
Overload protection		If the output amplifier overheats, the output is automatically switched off
Trigger inputs		4 external trigger inputs via STB8 (one per channel pair)
Ground reference	Analogue outputs	GND_AO
	AO trigger inputs	TRIG_AO_GND

* The actual achievable output rate depends strongly on the performance of your computer, the number of cards installed and the number of channels used.

Small signal relay for AI and AO part

Element	Condition	Specification
Type		FTR-B3CA()Z standard
Quantity	AI-part	Up to 5 relays in the AI signal path
	AO-part	2 relays in AO signal path
Type of contact		2-pin changeover contact (DPDT)
Contact material		Silver/Nickel with gold plating
Contact resistance	1 A/6 VDC	max. 75 mΩ at 1 A/6 VDC
Switching time	Response time	max. 3 ms
	Release time	max. 3 ms
Switching cycles	Mechanical	min. 50.000.000

Relay type S34 on the ADQ-SCU-BB (for auxiliary voltages)

Element	Condition	Specification
Quantity/Type		8 changeover contact relay (SPDT), type: Finder series 34
Contact material		Silver/Nickel
Switching time	Response time	max. 5 ms
	Release time	max. 3 ms
Switching cycles	Mechanical	min. 10.000.000
Switching current DC1		max. 6 A / 30 VDC (limited to 4 A by polyfuse)
Min. switching load	mW (V/mA)	500mW (12V/10mA) must not be fallen below, whereby at 24V a minimum current of 21mA or at 10mA a minimum voltage of 50V should be given
Connection	Input	STB11..14
	Output	STB15

Isolated digital inputs via ADQ-SCU-BB

Unless otherwise specified here, the specifications of the ADQ-348 apply.

Element	Condition	Specification
Quantity	To the ADQ-348	1 x 8 bit digital input ports via STB6
Type		Isolated digital inputs (unidirectional) with Schmitt trigger characteristic according to IEC 61131-2 (type 1)
External supply	V_EXT_DI	15..35 VDC, typ. 24 VDC for control technology
Ground reference		GND_DI

Isolated digital outputs via ADQ-SCU-BB

Unless otherwise specified here, the specifications of the ADQ-348 apply.

Element	Condition	Specification
Quantity	To the ADQ-348	1 x 8 bit digital output ports via STB7

Element	Condition	Specification
Type		Isolated digital outputs (unidirectional) according to IEC 61131-2 (type 1)
External supply	V_EXT_DO	11..35 VDC; typ. 24 VDC for control technology
Ground reference		GND_DO

Relaisboard ADQ-SCU-RB-16/8 und ADQ-31

Element	Condition	Specification
Relay	Quantity/Type	16 changeover contact relay (SPDT), type: Finder series 34
	Contact material	silver/nickel
	Switching time	Response time max. 5 ms
		Release time max. 3 ms
	Switching cycles	min. 10.000.000 (mechanical)
	Switching current DC1	max. 6 A at 30 VDC
	Min. switching load	500mW (12V/10mA) dürfen nicht unterschritten werden, wobei bei 24V ein Mindeststrom von 21mA oder bei 10mA eine Mindestspannung von 50V gegeben sein sollte
	Connection	All relay contacts (NO/NC/COM) are connected to the plugs ST1A/ST1B..ST8A/ST8B guided
Status display	32 LEDs	
Relay small signal FTR	Quantity/Type	8 changeover contact relay (DPDT), type FTR
	Contact material	Gold/Silver/Nickel
	Switching time	Response time max. 5 ms
		Release time max. 3 ms
	Switching cycles	min. 100 x 10 ³ (mechanical)
	Switching current DC1	max. 30VDC 1A, 125VAC, 0.3A
	Contact resistance	max. 75mΩ bei 1A, 6 VDC
	Min. switching load	0.01mA, 10mVDC
	Connection	All relay contacts (NO/NC/COM) are connected to the pins ST1A/ST1B..ST8A/ST8B guided
Status display	32 LEDs	

Powerboard ADQ-SCU-PB-50

Element	Condition	Specification
High Current Relays	Quantity/Type	2 normally open relays (DPST), type: Finder series 67 (power relay)
	Contact material	AgSnO ₂
	Switching time	Response time max. 25 ms
		Release time max. 5 ms
	Switching cycles	min. 1.000.000 (mechanical)
	Switching current DC1	2 closing contacts per relay, switching in parallel: max. 2 x 50 A/ 100 VDC
	Connection	Single pole high current connectors of the type: Würth Electronic REDCUBE Direct Plug Terminal WP-PLUG
	Relais 1 Schaltpfad	ST1 to ST5 / ST2 to ST6
	Relais 2 Schaltpfad	ST4 to ST8 / ST3 to ST7
	Sense lines	Signal at relay input (U1_IN/U2_IN) can be measured via ST9
Status display	2 red LEDs	
Standard relay	Quantity/Type	8 normally open relays (SPDT), type: Finder series 34
	Contact material	Silver/Nickel
	Switching time	Response time max. 5 ms
		Release time max. 3 ms
	Switching cycles	min. 10.000.000 (mechanical)
	Switching current DC1	max. 6 A / 36 VDC, here max. 4 A due to maximum current of power measurement via INA226
	Min. switching load	500mW (12V/10mA) must not be fallen below, whereby at 24V a minimum current of 21mA or at 10mA a minimum voltage of 50V should be given
	Connection	Input (U_IN) via ST10, outputs (U2..5_OUT) via ST11
	Sense line	Signal at relay input (U_IN) can be measured via ST12
Status display	4 red LEDs	
Performance measurement	Channels	4 channels U2..5
	Current measurement	20 mΩ Shunt per relay input, measuring range 0..5 A
	Voltage measurement	at relay input (U_IN), measuring range 0..30 VDC
Control system	Relay	I ² C-controlled via PCF8574
	Powermeter	I ² C-controlled, 4 x INA226
Ground reference		GND_PC

I²C-Bus

Unless otherwise specified here, the specifications of the ADQ-348 apply.

Element	Condition	Specification
Modi		Standard mode (Sm): 100 KHz

Element	Condition	Specification
Busteilnehmer		Max. 128 devices addressable in slave mode; ADQ-SCU is always slave!
Bussignale	Via HDMI (STB18)	Clock line "Serial Clock" (I2C_SCL) Serial Data' data line (I2C_SDA)
Adressformat		7-bit slave address + read/write bit as LSB
Datenformat		Multi-byte capable (up to 16 data bytes per cycle)
Isolierung	Via Optocoupler (Typ: ISO1541)	For bus devices on baseboard (incl. temperature sensor and EEPROM), powerboard and relay board

Counter

Unless otherwise specified here, the specifications of the ADQ-348 apply.

Element	Condition	Specification
Meter type		32 bit down counter
Preset		32 bit Start value loadable
Mode		Single count to zero (retriggerable) or continuous with automatic reloading of the start value
Threshold value	Threshold value < Preset	Programmable threshold value that can trigger an interrupt if it matches the current counter value
Strobe	Strobe < Preset	Pulse duration adjustable in steps of 15.15 ns
SINK output (Mosfet driver) Strobe: $I_{max} = 200mA$	$U_{max} = 18VDC$ Low output Voltage: 0,03V	Recommended pull-up resistor = 220 ohms
Max. Output frequency		1MHz
Interrupt		At zero crossing or reaching the threshold value
Input	via HDMI (STB18)	Enable Input (CNT_EN) External trigger input (CNT_TRIG) External clock input (CNT_EXT_CLK)
Output	via HDMI (STB18)	Strobe-Output (CNT_OUT)

Incremental encoder port (in preparation)

Unless otherwise specified here, the specifications of the ADQ-348 apply.

Element	Condition	Specification
Meter type		16 bit up/down counter + direction of movement
Quadrature signal		A/B channel with 90° phase shift
Codierung		Gray-Code
Resolution		4 times per signal period ("every edge counts")
Error correction		Suppression of invalid states on hardware level
Pulse frequency Sensor		max. 33 MHz
Reset-Input		asynchronous reset, sets counter to 0000 Hex
Interrupt		One interrupt per direction when the count range is exceeded
Input	via STB10	Sensor input "Channel A" (INC_A) Sensor input "Channel B" (INC_B) External reset input (INC_EXT_RST)

Frequency measurement

Unless otherwise specified here, the specifications of the ADQ-348.

Element	Condition	Specification
Measuring range	Frequency (period)	$f_{IN} = 0.0153 \text{ Hz}$ ($T_{IN} = 65 \text{ s}$) to $f_{IN} = 660 \text{ kHz}$ ($T_{IN} = 1.5 \mu\text{s}$).
	Pulse duration (High)	T_{ON} at intervals of 15.15 ns
Resolution	Period & Pulse	15.15 ns (see also handbook of ADQ-340 chapter 3.7.2.5)
Accuracy	Depending on the system	$\pm 15.15 \text{ ns}$
Input	via HDMI (STB18)	Frequency measurement input (FRQ_IN) / $U_{\text{max}}: 18\text{VDC}$ FIN - 1MHz

PWM-Output

The specification applies to control with the ADQ-348.

Element	Condition	Specification
Square wave signal output	Frequency (period)	$f_{OUT} = 0.0153 \text{ Hz}$ ($T_{OUT} = 65 \text{ s}$) to $f_{OUT} = 660 \text{ kHz}$ ($T_{OUT} = 1.5 \mu\text{s}$).
	Pulse duration (High)	T_{ON} at intervals of 15.15 ns; $T_{ON\text{max}} = T_{OUT} - 15.15 \text{ ns}$
Duty cycle	Period duration/pulse duration	Min. 1% steps or finer (slow frequencies can be resolved more finely than high frequencies).
Resolution	Period & Pulse	15.15 ns
Input	via HDMI (STB18)	Enable-Input (PWM_EN)
Output	via HDMI (STB18)	PWM-Output (PWM_OUT), invertible by software
SINK output (Mosfet driver) PWM: $I_{\text{max}}: 200\text{mA}$	$U_{\text{max}} = 18\text{VDC}$ Low output Voltage: 0,03V	Recommended pull-up R = 220 ohms
Max. Output frequency		1MHz

7. Annex

7.1 Supplies

7.1.1 Cables

- **ADQ-CR-VHDCI-68M/68M-1,2m** (Art.-No. 150597)
Round cable double shielded from 68pin VHDCI male to 68pin VHDCI male, cables twisted in pairs, length: approx. 1.2 m
- **ADQ-CR-VHDCI-68M/68M-1,8m** (Art.-No. 146813)
round cable double shielded from 68pin VHDCI male to 68pin VHDCI male, cables twisted in pairs, length: approx. 1.8 m
- **ADQ-CR-HDMI-MM-1m** (Art.-No. 127015)
HDMI cable to connect the digital I/Os and trigger signals with the special connector block, length: 1 m
- **ADQ-SCU-PB-50** Powerboard (Art.-No. 150555)
- **ADQ-RB-32/0** Relay board 32 x SPDT (Art.-No. 181065)
- **ADQ-RB-16/8** Relay board 16 x SPDT & 8 x DPDT (Art.-No. 178675)
- **ADQ-62 / ADQ-LINK-STAR** (Art.-No. 185077)
Distribution box to connect further ALLDAQ peripherals

7.2 Manufacturer and support

ALLNET® is a registered trademark of ALLNET® GmbH Computersysteme. For questions, problems and for product information of all kinds please contact the manufacturer directly:

ALLNET® GmbH Computersysteme

Division ALLDAQ

Maistrasse 2

D-82110 Germering

E-Mail: support@allda.com

Phone: +49 (0)89 894 222 – 474

Fax: +49 (0)89 894 222 – 33

Internet: www.allda.com

7.3 Important notes

7.3.1 Packaging ordinance

"Both manufacturers and distributors are basically obliged to ensure that sales packaging is taken back from the final consumer after use and is reused or recycled. (according to § 4 sentence 1 of the packaging ordinance). If you as a customer have problems disposing of the packaging and shipping materials, please write an e-mail to info@allnet.de.

7.3.2 Recycling advice and RoHS conformity

Please note that parts of the products of ALLNET® GmbH should be handed in at recycling centres or may not be disposed of with household waste (printed circuit boards, power supply unit, etc.).



ALLNET® products are manufactured RoHS compliant (RoHS = Restriction of the use of certain hazardous substances).

7.3.3 CE identification

The ADQ-SCU bears the CE-mark.



This device complies with the requirements of the EU Directive 2004/108/EC, Directive on Electromagnetic Compatibility and Mutual Recognition of Conformity. Conformity with the above directive is confirmed by the CE mark on the device.

7.3.4 Warranty

Within the warranty period, we will eliminate manufacturing and material defects free of charge. You will find the warranty conditions valid for your country on the homepage of your distributor. If you have any questions or problems concerning the application, you can reach us during our normal opening hours at the following telephone number +49 (0)89 894 222 - 474 or by e-mail to: support@alldaq.com.



ALLNET® GmbH Computersysteme
Division ALLDAQ
Maistrasse 2
D-82110 Germering
E-Mail: support@alldaq.com
Phone: +49 (0)89 894 222 – 474
Fax: +49 (0)89 894 222 – 33
Internet: www.alldaq.com

